

YOXIMO Mobile

User guide

Table of contents

1	Security requirements	3
1.1	Electromagnetic compatibility	3
1.2	Where wireless technologies are used	3
2	Product info	4
2.1	Terminal overview	4
2.2	Display symbols	5
2.3	Loading station: table/wall installation and clip holder	7
2.4	Changing the rechargeable battery/Installing SIM cards	8
2.5	Abbreviations/Information	9
2.6	Mobile connection	10
2.7	Wifi	10
2.8	Turning a communication type on/off	10
2.9	Setting mobile communication	11
2.10	Stand-by operation	11
2.11	Payment procedure with ep2	11
2.12	Technical information	11
3	Start-up	12
3.1	Installation	12
4	Menu tree (illustration)	13
4.1	Main menu	13
4.2	Transactions	14
5	Transactions	15
5.1	Purchase	15
5.2	Purchase authorized per phone	19
5.3	Cancellation	19
5.4	Credit	20
5.5	Additional transactions	20
6	Balances	21
6.1	Start user shift/end user shift, daily closing, data transmission	21
7	Queries (totals), settings	22
8	Setup	23
9	Additional services	24
10	Maintenance and handling	25
10.1	Identifying and solving errors	25
10.2	Improve the battery life	25
10.3	Changing the paper roll	26

1 Security requirements

1.1 ELECTROMAGNETIC COMPATIBILITY

When connecting additional or other components the guidelines of the “Electromagnetic Compatibility Directive” (EMC) must be adhered to.

1.2 WHERE WIRELESS TECHNOLOGIES ARE USED

While driving

Radio frequencies can interfere with electronic systems in vehicles, such as car radios or security devices, etc.

Vehicles equipped with airbags

An enormous force is released when airbags are activated. Therefore, do not place the terminal in the area above the airbag or in the space in which the airbag could deploy. Terminals that are improperly installed can cause serious injury upon deployment of an airbag.

Electronic devices

Most morn electronic devices, such as those used in hospitals and vehicles, are protected against radio frequencies. However, this is not the case with all electronic devices. Do not use your terminal in the proximity of medical equipment without obtaining prior permission.

Heart pacemaker/other medical devices

Terminals can affect the functioning of implanted heart pacemakers and other medically implanted devices. Patients with a heart pacemaker should be informed that the use of terminals in the immediate vicinity of a pacemaker can lead to malfunctions. Do not pass the terminal over the pacemaker. The risk of a malfunction however, is minor if a minimum distance of 15 cm between the terminal and the pacemaker is maintained. If you suspect that malfunctions are occurring, put the terminal aside. If necessary, consult your cardiologist. If other medical devices are used in or on the body, then the equipment manufacturer should be consulted as to whether such devices are sufficiently protected against radio frequency signals. Do not use the terminal where the devices are implanted.

Hearing aids

Under certain circumstances, terminals can cause some hearing aids to malfunction. Contact the dealer/manufacturer of your hearing aid.

Other medical equipment

If you use a medical device, please contact the manufacturer to determine whether it is sufficiently protected against electromagnetic waves. If necessary, your attending physician could be helpful in obtaining this information. Equipment is often used in hospitals, medical offices and other facilities which is highly sensitive to external electromagnetic waves. Do not use the terminal in such locations.

Aeroplanes

To avoid interfering with the communication systems, do not use the terminal during the flight. Only activate the terminal on the ground with permission from the ground personnel.

Potentially explosive areas

Do not use the terminal in explosive zones or areas bearing signs with “Switch off sending/receiving devices”. Do not use the terminal in such potentially explosive locations.

Appropriately marked locations

Follow instructions and do not use the terminal in locations with obvious signs and instructions prohibiting such use.

Every effort has been made to ensure that the information in this document is complete and exact at the date of printing. Further developments in the field of electronic payment traffic and technological progress could result in changes that might deviate from the description in this user guide.

Consequently, Worldline accepts no responsibility for the information provided in the operating instructions being current, complete or

correct. Furthermore, to the extent permitted under the relevant legal provisions, Worldline Ltd accepts no responsibility in connection with the operating instructions. The menu navigation on the terminal has been designed to be self-explanatory, making this document necessary only in case of emergency.

The latest version of the user guide, together with any updates, can be found on our homepage at: worldline.com/merchant-services

2 Product info





2.1 TERMINAL OVERVIEW



- 1 Thermal printer**
- 2 Magnetic strip reader (on the side)**
For cards with magnetic strips.
- 3 Display**
The next step to be taken is always shown on the display.
- 4 Contactless reader (RFID)**
For contactless paying.
- 5 Special case**
<Confirmation special signalization>.
- 6 Navigation buttons**
You can use these three buttons to navigate through the menu (up/down/confirm).
- 7 <Menu> button**
Change the keyboard settings using the <Menu> button.
- 8 <OK> button**
All entries must be confirmed using the <OK> button.
- 9 <Corr/On> button**
 - Incorrect entries can be corrected using the <Corr> button.
 - Press the button to activate the terminal from stand-by mode.
 - The terminal will restart if the button is pressed for more than 5 seconds. All data will be retained.
- 10 <STOP> button**
Active procedures can be stopped using this button. The terminal can also be switched off completely by pressing the button for more than 5 seconds (to do so, the terminal must not be connected to the power supply).
- 11 Chip reader**
For chip cards.
- 12 View protection**
The swipe and chip reader can only be used when the view protector is raised.
The view protection cannot be removed!

2.2 DISPLAY SYMBOLS

Battery

	Battery level 95 – 100%
	Battery level 66 – 95%
	Battery level 33 – 66%
	Battery level 10 – 33%
	Battery level 0 – 10%





If the battery symbol does not appear, the battery is empty.

Recharging: The symbols are shown in the following order when the battery is recharging:



Wifi

Only appears when Wifi communication is used.

	Wifi is connected to an access point, the IP address is valid, and the reception strength is 100%.
	Wifi is connected to an access point, the IP address is valid, and the reception strength is greater than 66%.
	Wifi is connected to an access point, the IP address is valid, and the reception strength is greater than 33%.
	Wifi is connected to an access point, the IP address is valid, but reception is poor.

If the Wifi symbol flashes, there is a connection to the access point, but the IP address is invalid.

If the Wifi symbol does not appear, either Wifi is not available or there is no connection to the access point.

Mobile communication reception strength

Icon only appears if you are within the coverage area of the mobile network.



There is a connection to the network and the reception strength is 100%.



There is a connection to the network and the reception strength is greater than 80%.



There is a connection to the network and the reception strength is greater than 60%.



There is a connection to the network and the reception strength is greater than 40%.



There is a connection to the network and the reception strength is greater than 20%.

If the mobile communication symbol does not appear, 3G/GPRS is not assigned to a network or reception is too poor to set up a connection.

The reception strength is supplemented by one symbols shown below.



GSM is in use, 3G/GPRS is not available/in use.

If the mobile communication symbol flashes, it is in use but offline.



GSM/GPRS is in use (GPRS mode).

If no supplementary symbol appears, GSM/GPRS is not available.



3G is in use.

Mobile communication data transmission



This symbol always appears together with a communication symbol.

2.3 LOADING STATION: TABLE/WALL INSTALLATION AND CLIP HOLDER

Table loading station installation

- 1 Loading station with power supply.
- 2 The **electrical current** is supplied through the cable that connects directly with the loading station.

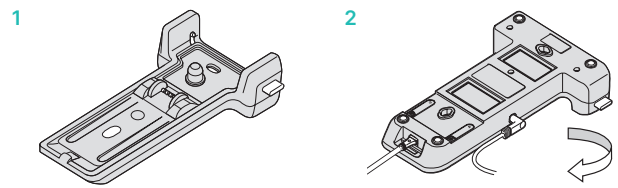

Wall mount installation

- 1 The loading station is screwed to the **wall mounting** component (screw holes provided, see back of loading station).
- 2 **Wall mounting** (screw holes provided).
- 3 After the loading station has been positioned on the wall, connect it to the **power supply** using the cable provided.

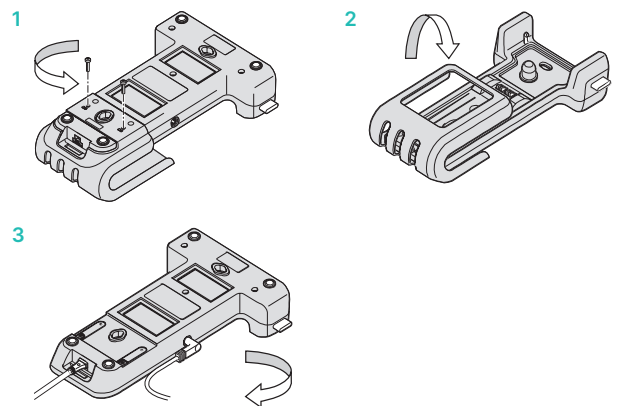

Inserting the YOXIMO into the loading station

- 1 Insert the YOXIMO from top to bottom.
- 2 Snap into the side clamps.

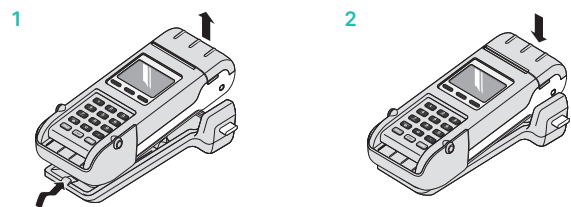

Removing the YOXIMO from the loading station

- 1 Press the two side buttons simultaneously.
- 2 Slide back and upwards to remove the unit.

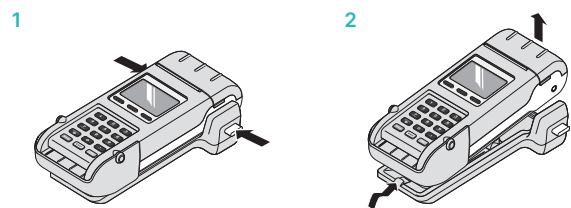

2.4 CHANGING THE RECHARGEABLE BATTERY/INSTALLING SIM CARDS

The lifespan of the rechargeable battery is three years. Replacement batteries can be obtained from Worldline.

The rechargeable battery can be replaced in four steps:

- 1 Press the tag with your thumb and remove the cover.
- 2 Remove the rechargeable battery.
- 3 Insert the new rechargeable battery and press it into place.
- 4 Slide the cover back into position.

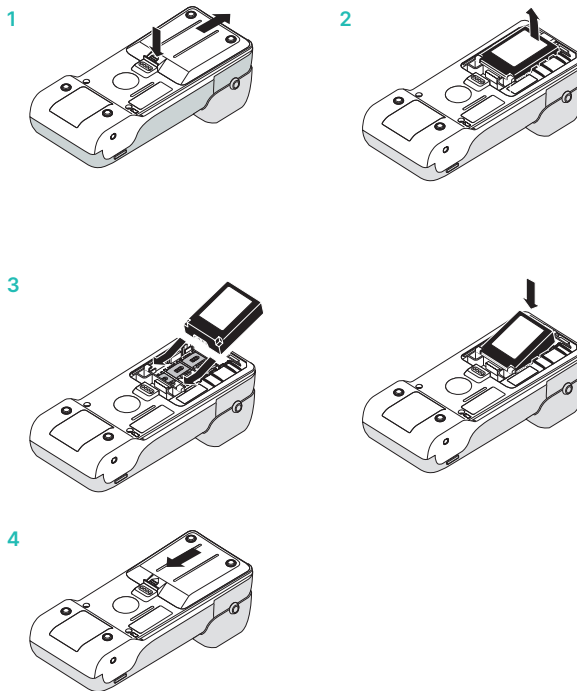

Installing SIM cards

(generally performed by Worldline, see point 2.6 Mobile connection)

- 1 Remove the rechargeable battery.
- 2 Remove the SIM card (to the left!) and insert the new card. Replace the cover and close.

Be sure to insert SIM card with the oblique corner facing in the right direction!

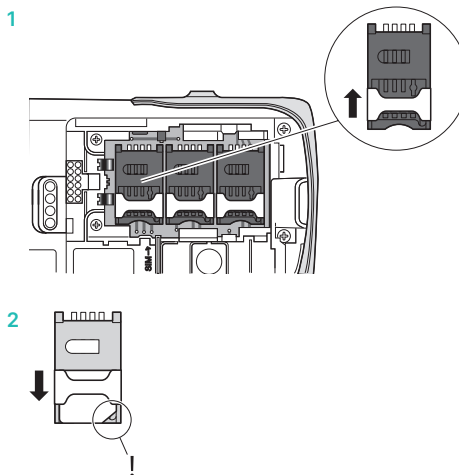

2.5 ABBREVIATIONS/INFORMATION

Cards with a chip	Cards which store the information needed for electronic payment on a chip must be inserted in a chip reader, depending on the terminal model. If the terminal is equipped with a motor reader, then the card is automatically drawn in and read.
Cards with a contactless chip	Cards that have a chip featuring a contactless function can be held up to contactless readers to speed up the payment process.
Cards with a magnetic stripe	Cards which store the information needed for electronic payment on a magnetic stripe must be pulled through the swipe reader, depending on the terminal model. If the terminal is equipped with a motor reader, then the card is automatically drawn in and read.
CC	Computer center
CCC	Credit card company
CLP	Contactless payment
CrC	Credit cards
CVC/CVV	Card Verification Code/Card Verification Value number used to identify the card.
DCC	Dynamic Currency Conversion. Foreign cardholders can pay in their domestic currency.
EFT/POS	Electronic Funds Transfer at the Point Of Sale
EMV	Global specifications from Eurocard, Mastercard and Visa based on a chip card.
ep2	<EFT/POS 2000>, Swiss standard based on the EMV standard in electronic payment traffic.
GPRS	General Packet Radio Service (GPRS) is a packet-oriented transmission service that is used in the field of mobile telephone systems.
GSM	Global Standard for Mobile Communications
Online transaction	An online transaction is always directly authorised at the CCC.
Offline transaction	An offline transaction is authorised in interdependence with the card and terminal risk management (e.g. if the amount of the previous transactions is less than the card limit or if the amount is less than the terminal floor limit on the card, etc.).
PF	PostFinance (Switzerland)
PIN	Personal Identification Number
PIN-based transaction	For a PIN-based transaction, the customer must enter his/her PIN at the point of sale during the payment process.
PW	Password
PUK	Personal Unblocking Key
RFID	Radio-frequency identification
TFP	Tax-Free Provider with whom the retailer uses the optional Tax-Free Service.
TFS	The Tax-Free Service, which is optionally performed by one of the supported Tax-Free Providers.
TIP	Tip
Trm	Terminal
Trx	Transaction
WLAN	A Wireless Local Area Network is a "wireless" local radio network, which generally refers to a standard within the IEEE 802.11 family.

2.6 MOBILE CONNECTION

YOXIMO Mobile Flex requires a mobile data subscription with a mobile communications provider.

The PIN/PUK must usually only be entered once. This is done when the terminal is commissioned at the Worldline production facility. Keep your PIN and PUK for your data subscription handy in case of a malfunction.

- The reception signal can vary greatly, depending on the mobile communications provider and usage environment. It is possible that the signal may be weakened to the point that communications are impossible in cellars, houses with thick walls or steel walls.
If there is no reception, you must change your location.
- Communications while in motion (in trains, cars, boats, etc.) can become instable and lead to a broken connection.
- We recommend you sign up for the mobile subscription via Worldline.

2.7 WIFI

Several tips for working with a Wifi terminal:

- Please read the installation instructions (worldline.com/merchant-services/download)
- Have your network infrastructure installed and tested in advance by a qualified IT specialist.
- Keep the SSID and the keys for the radio link in a secure location. Make sure that you have this data to hand in the event of technical problems.
- The terminal uses the wireless communications standard IEEE 802.11b/g/n (with a communications speed of up to 150 Mbps [obstacle-free]).

- We recommend that you inspect the location before installing the terminal. Determine where the terminal functions in your building and where the radio signal is limited.
- The power of radio links can be effect by weather. The signal reception may therefore vary. You can display the current reception level by pressing the <Menu> button.
- The useful range of the terminal can be extended with the installation of additional access points. Ask the person in charge of your network.

2.8 TURNING A COMMUNICATION TYPE ON/OFF

As soon as a Wifi is available in addition to mobile data communication for YOXIMO Flex, Wifi becomes the main communication type. If the Wifi is not available for transmitting transactions (availability of less than 20%), the payment terminal switches to 3G/2G.

If you do not wish to use this active communication switching, **deactivate** a communication type. To do this, select the following items in the menu using the keyboard:

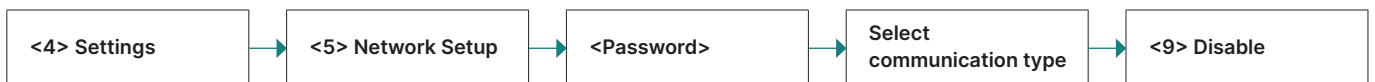

To **activate** a communication type, proceed as follows:



2.9 SETTING MOBILE COMMUNICATION

YOXIMO Flex automatically switches between 2G and 3G depending on which signal is stronger. If there are problems with switching in your area, you can set a mobile communication type.

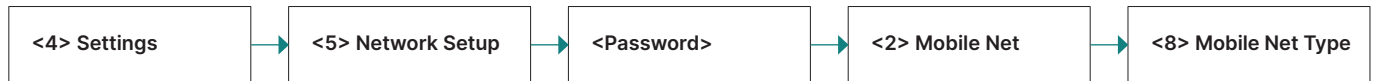

2.10 STAND-BY OPERATION

The terminal is always ready for operation if it is connected to the power supply (transformer or loading station). If the terminal is to be used in mobile mode on battery power, then

it will automatically switch to stand-by mode if not used for approximately 60 seconds to preserve the battery. Make the terminal operational again by pressing the <Corr/On> button.

2.11 PAYMENT PROCEDURE WITH EP2

The payment process at the point of sale is standardised for all cards with ep2. A variety of card types are in circulation today.

Payment functions

ep2 offers a full range of transaction modes and functions. The transactions activated on your terminal are determined by the settings in the service centre as global parameters and by the individual card processors.

e.g. TIP:

This transaction type is often used in the hotel and restaurant industry. In the retail business, however, it is unnecessary.

- Depending on the payment function and credit card processor, different minimum/maximum amounts, day limits, etc. can be defined.
- Functions are described in general in the sections that follow. Please note that some transaction modes and functions may be inactive on your terminal.

Caution for offline transactions!

Offline transactions are stored in the security section of your terminal and submitted to the card processor by means of the daily closing. This can be carried out manually by the terminal operator or automatically.

Should the security section of the device be defective, intentionally damaged or stolen, the transactions that have not been stored will be lost.

For this reason, we recommend that you:

- Meticulously retain all sales slips.
- Carry out a daily closing every day or more often.
- Always carry out a daily closing before making installation changes, etc.
- Always carry out a daily closing for anticipated longer absences from the business.
- A closing must be carried out for seasonal operations, at the end of the season.

2.12 TECHNICAL INFORMATION

Operating temperature

-10 °C to 50 °C

Humidity (not condensing)

20% to 95%

Power supply

100 – 240 VAC 50 – 60 Hz

3 Start-up

3.1 INSTALLATION

First initialisation







The YOXIMO will generally already have been commissioned by the Worldline production facility. Additional instructions are provided to you in the "Configuration instructions for YOXIMO" delivered along with the terminal.

Subsequent initialisation

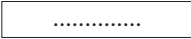
Should it be necessary to re-initialise a device for any reason, proceed as outlined on [page 23](#).

Key

The following symbols are used in the descriptions in this document.

	Function selection by choosing the corresponding number or using the cursor and the <OK> button.
	Insert card. Depending on the card type, it must be inserted in the chip card reader, held up to the contactless reader or pulled through the magnetic swipe reader.
	Remove card.
	Sales slip printout.
	Request the customer's signature.
	Processing and/or communication.
	Manual entry of the card data. Press function button.

4 Menu tree (illustration)

4.1 MAIN MENU

To enter the menu tree below, press the <STOP> button.

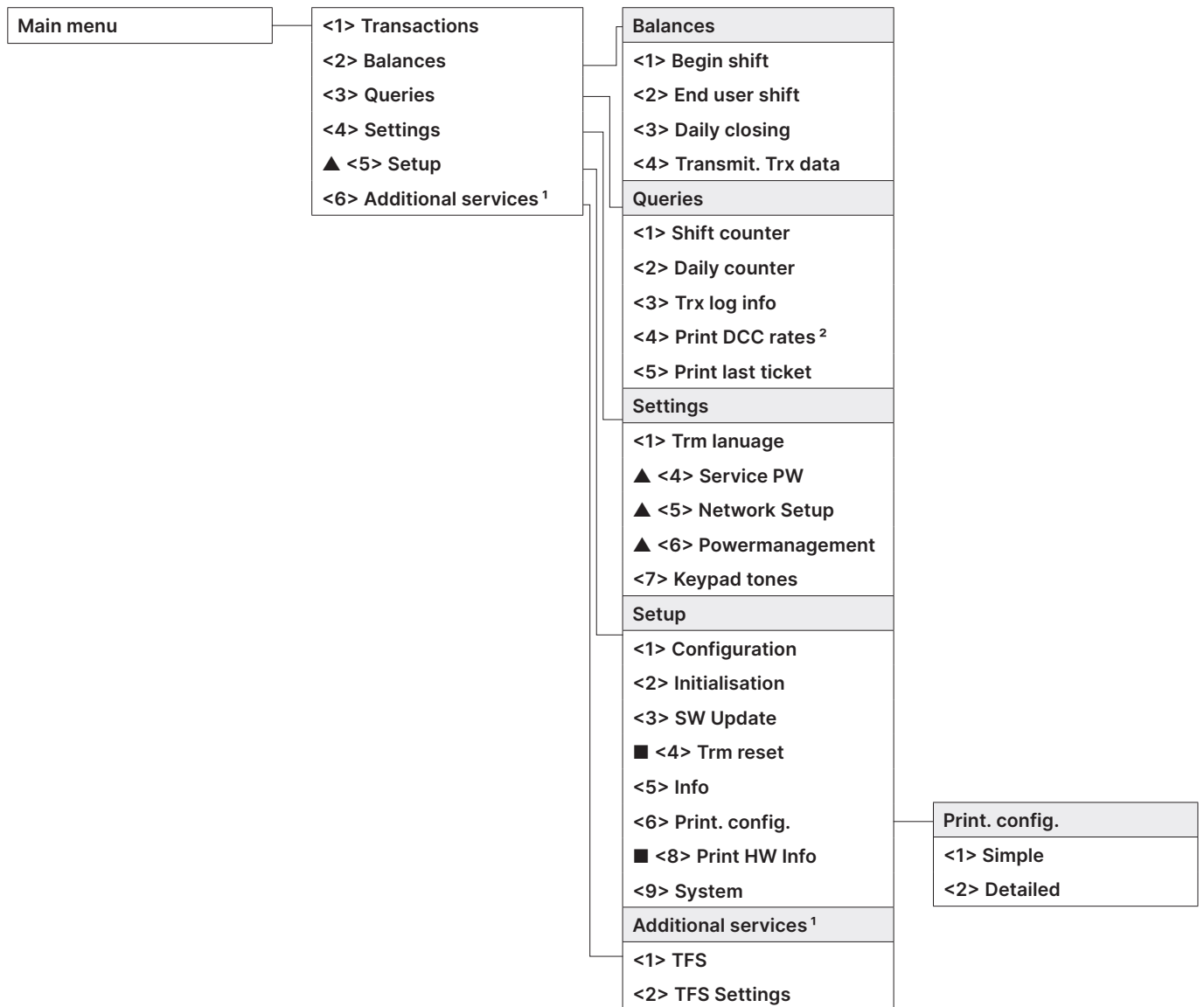

▲ Access only with your password. You can find this on the configuration sheet delivered with your terminal.

■ Access only for service technicians.

¹ "Additional services" makes other optional services available.

² This function may not be activated depending on the CCC.

4.2 TRANSACTIONS

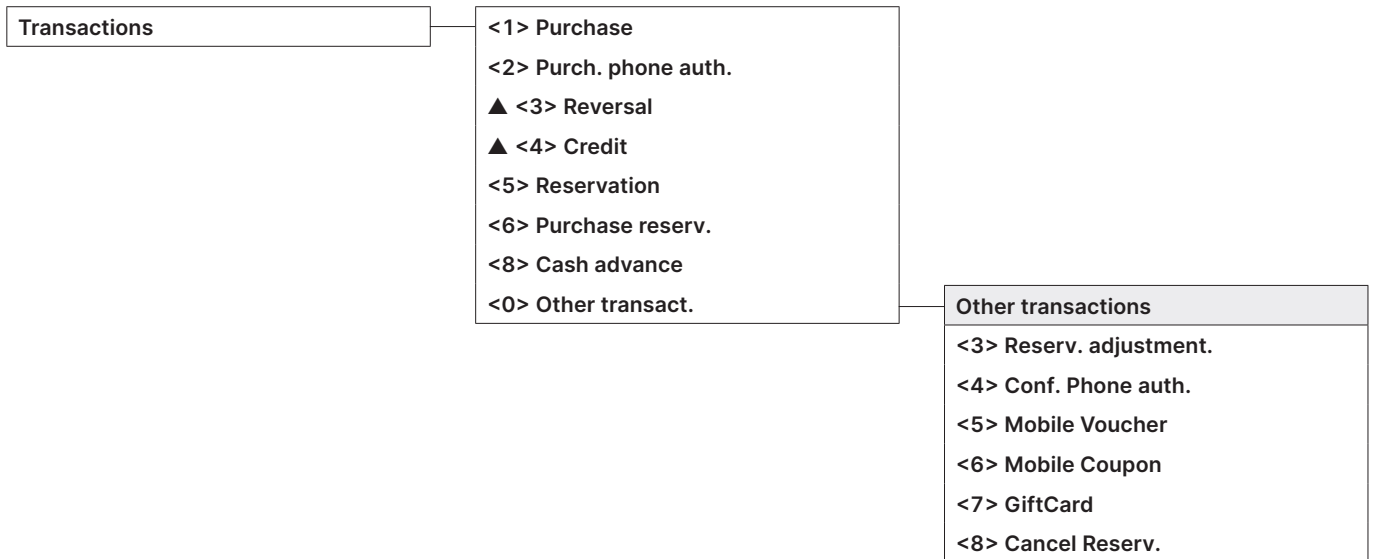

▲ Access only with your password. You can find this on the configuration sheet delivered with your terminal.

5 Transactions

5.1 PURCHASE

<1> Purchase

The purchase is the most common transaction type in electronic payment traffic.

- Depending on the CCC, minimum/maximum amounts, day limits, etc. may vary.
- The “manual recording of card data” and “subsequent cancellation” functions are either activated or deactivated, depending on the CCC.

Cashier handling

1	Press “1”. “Purchase” will be activated.	1: Purchase
2*	If the “foreign currency” function is activated on your terminal, you must select the desired currency. * Menu only appears if 2 or more currencies are activated.	<Currency>
3	Enter the amount and confirm with <OK>. The amount must be separated with a decimal point. For amounts below CHF 1.00, a zero “0” must be entered first (e.g., CHF 0.55).	Amount OK
3a (DCC) ¹	If the cardholder prefers to make a transaction in CHF, this can be selected with the “CHF” function button.	
4	Proceed with card processing as detailed on pages 17 and 18 , or enter manually as detailed on page 16 .	

¹ This menu item is only shown if DCC is activated. The terminal automatically recognizes if the card is one that is in a DCC-capable foreign currency and automatically chooses DCC. Otherwise, the transaction will be processed in CHF. If the cardholder prefers to make a transaction in CHF, this can be selected with the “CHF” function button. As soon as the card has been read in, CHF can no longer be selected!

Sample sales slip: Certain fields may differ according to the purchase type.

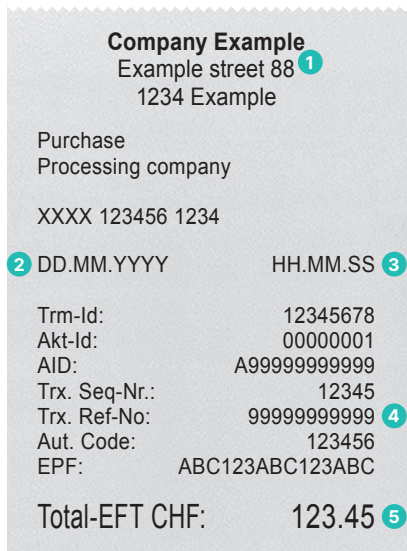

- 1** Your company data, which will be printed out on the sales slip.
- 2** Transaction date.
- 3** Transaction time.
- 4** Transaction information for unambiguous identification of the transaction.
- 5** Amount



Cashier: manual card data entry

Should a **credit card** be unreadable, the card data can be entered manually.

To do so, you need the card number, the expiry date, and for newer cards, the CVC/CVV (Card Verification Code/

Card Verification Value). This 3-digit code is printed on the reverse side of the card (the last three numbers).

After you have chosen the transaction mode and confirmed this by pressing <OK>, manual entry can be activated using the corresponding function button.

1*	If the "foreign currency" function is activated on your terminal, you must select the desired currency. <small>* Menu appears only if two or more currencies are activated.</small>	<Currency>
2	Enter the amount and confirm with <OK>. The amount must be separated with a decimal point. For amounts below CHF 1.00, a zero "0." must be entered first.	Amount OK
3	Press the "Manual" button for manual recording.	MANUAL ▾
4	Enter the card number and press <OK>.	Card number OK
5	Enter the card expiry date and confirm with <OK>.	Expiry date OK
6	Enter the CVC2 respectively CVV2 and confirm with <OK>. Tip! For cards without a CVC, press <OK> without entering the CVC.	CVC2/CVV2 if present OK
7	Payment is recorded and authorised online, if this function is activated.	
8	A sales slip is printed out. The sales slip must be signed by the customer.	
9	If a copy is desired → press 1. If no copy is desired → press 2. If no button is pressed, the copy will be automatically printed out after 10 seconds.	1 : Copy or 2 : No copy

Example:

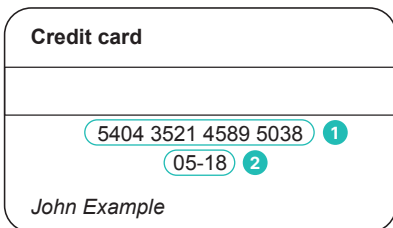

- 1 Card number
- 2 Expiry date
- 3 CVC2/CVV2

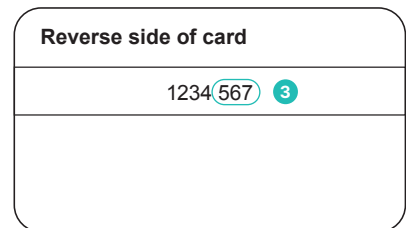





After the cashier enters the amount, the customer is prompted by the terminal to use his or her card.

Depending on the card type, the two following procedures are possible:

- Customer handling: card without PIN.
- Customer handling: card with PIN (see page 18).





Customer handling: card without PIN

1	The amount is shown.							
2	Depending on the card type, it must be inserted in the chip card reader, held up to the contactless reader or pulled through the magnetic swipe reader. If the customer uses the wrong reader for his or her card, that person is instructed to use the proper reader.							
2a (TIP) ¹	If the TIP function is activated, after the original amount is confirmed, the option of entering a tip is also offered and confirmed by pressing <OK>. If the guest does not wish to give a tip, he/she can continue without entering an amount by pressing <OK>.	Tip: OK						
2b (DCC) ²	Customer chooses whether he/she wishes to pay with DCC or in CHF.	<table border="1"> <tr> <td>1. CHF</td> <td>100.00</td> </tr> <tr> <td>2. EUR</td> <td>66.33</td> </tr> <tr> <td>ExRate</td> <td>1.463486</td> </tr> </table>	1. CHF	100.00	2. EUR	66.33	ExRate	1.463486
1. CHF	100.00							
2. EUR	66.33							
ExRate	1.463486							
3	The amount is shown. Confirm the amount with <OK>.	OK						
4	Payment is recorded and authorized online if necessary.							
5	Remove the card.							
6	The sales slip is printed out. The sales slip must be signed by the customer.							
7	If a copy is desired → press 1. If no copy is desired → press 2. If no button is pressed, the copy will be automatically printed out after 10 seconds.	1 : Copy or 2 : No copy						

¹ This menu item is only shown if TIP is activated. This function is only activated for hotels and restaurants by the card organizations. In addition to the adjustments in the payment procedure, this modification also has an impact upon the payment receipt and the daily closing printout.

² This menu item is only shown if DCC is activated. The terminal automatically recognizes if the card is one that is in a DCC-capable foreign currency and automatically chooses DCC. Otherwise, the transaction will be processed in CHF. If the cardholder prefers to make a transaction in CHF, this can be selected with the "CHF" function button. As soon as the card has been read in, CHF can no longer be selected!

Customer handling: card with PIN

1	The amount is shown.							
2	Depending on the card type, it must be inserted in the chip card reader, held up to the contactless reader or pulled through the magnetic swipe reader. If the customer uses the wrong reader for his or her card, that person is instructed to use the proper reader.							
2a (TIP) ¹	If the TIP function is activated, after the original amount is confirmed, the option of entering a tip is also offered and confirmed by pressing <OK>. If the guest does not wish to give a tip, he/she can continue without entering an amount by pressing <OK>.	Tip: OK						
2b (DCC) ²	Customer chooses whether he/she wishes to pay with DCC or in CHF.	<table border="1"> <tr> <td>1. CHF</td> <td>100.00</td> </tr> <tr> <td>2. EUR</td> <td>66.33</td> </tr> <tr> <td>ExRate</td> <td>1.463486</td> </tr> </table>	1. CHF	100.00	2. EUR	66.33	ExRate	1.463486
1. CHF	100.00							
2. EUR	66.33							
ExRate	1.463486							
3 (CLP) ³	The total is displayed and the customer is requested to enter the PIN code (4- to 6-digit) and to confirm with <OK>. If the amount is incorrect, the transaction can be aborted using <STOP>. Timeout: The process will be aborted if the processing does not occur within 30 seconds.	<PIN> OK						
4	Payment is recorded and authorized online if necessary.							
5	Remove the card.							
6	The sales slip is printed out. The sales slip must be signed by the customer.							
7	If a copy is desired → press 1. If no copy is desired → press 2. If no button is pressed, the copy will be automatically printed out after 10 seconds.	1 : Copy or 2 : No copy						

¹ This menu item is only shown if TIP is activated. This function is only activated for hotels and restaurants by the card organizations. In addition to the adjustments in the payment procedure, this modification also has an impact upon the payment receipt and the daily closing printout.

² This menu item is only shown if DCC is activated. The terminal automatically recognizes if the card is one that is in a DCC-capable foreign currency and automatically chooses DCC. Otherwise, the transaction will be processed in CHF. If the cardholder prefers to make a transaction in CHF, this can be selected with the "CHF" function button. As soon as the card has been read in, CHF can no longer be selected!

³ Generally, the PIN entry is not required for contactless payment of smaller amounts. However, this is controlled by the card issuer and may vary.



5.2 PURCHASE AUTHORIZED PER PHONE

<2> Phone authorised

This purchase mode is used when the authorisation cannot be made automatically. The authorisation code is issued by

a CCC representative by telephone. With the function "Phone authorised", the transaction will be recorded later.

Cashier handling

1	Press "2". The "Phone authorized" function is activated.	2: Phone authorized
2*	If the "foreign currency" function is activated on this terminal, then the desired currency must be select. * Menu only appears if 2 or more currencies are activated.	<Currency>
3	Enter the amount and confirm with <OK>. The amount must be separated with a decimal point. For amounts below CHF 1.00, a zero "0" must be entered first (e.g., CHF 0.55).	Amount 
3a (DCC) ¹	If the cardholder prefers to make a transaction in CHF, this can be selected with the "CHF" function button.	
4	Enter the authorization code and confirm with <OK>.	Authorization code 
5	Card handling according to pages 17 and 18 , or page 16 for manual entry.	

¹ This menu item is only shown if DCC is activated. The terminal automatically recognizes if the card is one that is in a DCC-capable foreign currency and automatically chooses DCC. Otherwise, the transaction will be processed in CHF. If the cardholder prefers to make a transaction in CHF, this can be selected with the "CHF" function button. As soon as the card has been read in, CHF can no longer be selected!





5.3 CANCELLATION

<3> Cancellation

The purchase which has **just been made** can be cancelled using the "Cancellation" function.

- With some CCC's this function may not be activated.
- If a daily closing or shift-end has been carried out in the meantime, or if the data has been transmitted, then cancellation is no longer possible.

Cashier handling



1	Press "3" to activate the "Cancellation" function.	3: Cancellation
2	Enter the terminal's password and confirm with <OK>. (See configuration sheet for the password.)	Password 
3	The amount of the last transaction is shown. If the amount of the last transaction is correct, then confirm this by pressing the <OK> button.	
4	Cancellation is recorded and, if necessary, authorised online.	
5	A sales slip is printed out.	
6	If a copy is desired → press 1. If no copy is desired → press 2. If no button is pressed, the copy will be automatically printed out after 10 seconds.	1 : Copy or 2 : No copy

5.4 CREDIT

<4> Credit

A purchase that has been made can be corrected using the "Credit" function. This is used if a cancellation is no longer possible.

Cashier handling

1	Press "4". "Credit" will be activated.	4 : Credit
2	Enter the password and confirm with <OK>. (See the configuration sheet for the password)	Password 
3*	If the "foreign currency" function is activated on this terminal, then the desired currency must be selected. <small>* Menu only appears if 2 or more currencies are activated.</small>	<Currency>
4	Enter the amount and confirm with <OK>. The amount must be separated with a decimal point. For amounts below CHF 1.00, a zero "0" must be entered first (e.g., CHF 0.55).	Amount 
4a (DCC)	If DCC is activated, then the date of the original transaction must also be entered.	Orig. Trx date (YYYYMMDD)
5	The amount is shown and the card requested.	
6	Card handling according to pages 17 and 18 , or page 16 for manual entry. The cashier signs the sales slip!	

5.5 ADDITIONAL TRANSACTIONS

In addition to the payment types described, your terminal also contains other functions that are generally only used very rarely. The operation of these additional functions corresponds to the same logic as that used for the standard functions. Please follow the instructions issued by the terminal. Contact our hotline if you have difficulties with a function.

<5> Reservation

and

<6> Purchase reserv.

(purchase of a previously made reservation)

With <5> Reservation (e.g., hotel, rental car, flight ticket, etc.) an amount can be booked to the credit card. The entire amount or even just a partial amount can be subsequently purchased with <6>.

<7> Cash advance

The cash advance function enables the customer to obtain cash at the point of sale.

<8> Mail Order

Distance payment purchases are handled with Mail Order. In this case, the customer provides the card number, the expiry date (and the CVC, if needed) to the merchant by fax, mail or the Internet shop. If a contract for Mail Order has been signed, then the merchant generally can no longer carry out any normal bookings (<1> function).

Worldline offers an ideal virtual solution for mail order under the Safepay brand.

6 Balances

6.1 START USER SHIFT/END USER SHIFT, DAILY CLOSING, DATA TRANSMISSION

<STOP> <2>

Balances

You can enter the terminal's main menu using the <STOP> button. Select the "Balances" function <2>. You then have the following options:

<STOP> <2> <1>

Start user shift (o)

You can start a user shift autonomously when you begin working. If you attempt to make a transaction after the end of a shift or daily closing, then the terminal automatically starts a new shift.

<STOP> <2> <2>

End user shift (o)

With the "End user shift" function you end the current shift. Delivery of the transactions is carried out automatically. The daily closing, however, remains open.

- No further cancellations can be made after a shift end.
- No further tips can be recorded after a shift end.

<STOP> <2> <3>

Daily closing (m)

With the "Daily closing" function, all transactions that have been made are delivered to the card processors and completed. All amounts are credited to you after daily closing. A daily closing should be carried out at least once a day – preferably after the establishment has closed. The day and shift counter is set to "0".

- No further cancellations can be made after a "daily closing".
- No further tips can be recorded after a "daily closing".

<STOP> <2> <4>

Transmit trx data (o)

With the "Transmit trx data" function, all transactions that have been conducted and stored in the terminal are transmitted. This function should always be used if a large number of offline transactions has been made.

- No further cancellations can be made after a "Transmit trx data".
- No further tips can be recorded after a "Transmit trx data".

o = Optional: You can use this function according to your requirements.
m = Mandatory (this function is necessary for smooth operation)

7 Queries (totals), settings

<STOP> <3>

Queries

You can enter the terminal's main menu using the <STOP> button. Select the "Queries" function <3>. You then have the following options:

<STOP> <3> <1>

Shift counter

The current status of the active shift is printed out.

<STOP> <3> <2>

Daily counter

The current status since the last daily closing is printed out.

<STOP> <3> <3>

Trx log info

The current status of transactions since the last data transmission is listed.

<STOP> <3> <5>

Print last ticket

A copy of the last sales slip is printed out.

<STOP> <4>

Settings

You can enter the terminal's main menu using the <STOP> button. Select the "Settings" function <4>. You then have the following options:

<STOP> <4> <1>

Trm language

The terminal language can be adjusted.

This language setting is only applicable until the next service call. During the service call, the service host's language setting will be reactivated. If you prefer a permanent adjustment of the language setting, then this can be set by calling our hotline. The customer language corresponds to the card's language code.

<STOP> <4> <4>

Service PW

Set the service password for other transactions (e.g. Mobile Voucher).

<STOP> <4> <5>

Network setup

Set up communication for your YOXIMO here.

<STOP> <4> <6>

Power management

Select an energy mode to adjust battery life.

<STOP> <4> <7>

Keypad tones

Adjust the volume of the keypad tones. The adjustment must be confirmed with <OK>.

8 Setup

<STOP> <5>

Setup → Password is requested

You can enter the terminal's main menu using the <STOP> button. Select the <Setup> function <5>. The following terminal-specific functions can be carried out. The following functions require a **password**. You can find your password in the "Configuration instructions for YOXIMO".

<STOP> <5> <1>

Configuration

The terminal calls the service centre and obtains the latest configuration parameters in the event that they have changed.

<STOP> <5> <2>

Initialisation

You can re-initialise individual or all activated card products.

<STOP> <5> <3>

SW update

The terminal calls the service host and downloads the latest software version, if one exists. The software download may require several minutes. Please connect the terminal to the power supply for this purpose.

<STOP> <5> <4>

Trm reset

This function is only available to the service technicians and is protected by a separate password.

<STOP> <5> <5>

Info

The terminal ID and the current software version are displayed.

<STOP> <5> <6>

Print config

The current configuration can be printed out.
→ Please note that the detailed printout may require a great deal of paper.

<STOP> <5> <8>

Print hardware info

This function is only available to service technicians and is protected by a separate password.

<STOP> <5> <9>

System

This function is only available to the service technicians, and we recommend that you only use the function if requested to do so by our hotline.

9 Additional services

<STOP> <6>

Additional services

Pressing the <STOP> button takes you to the main menu of the terminal. Select function <6> Additional services. The terminal-specific functions indicated can be executed.

<STOP> <6> <1>

TFS settings

This menu leads to the Tax-Free Service settings.

<STOP> <6> <2> <1>

Activate Tax-Free

In this sub-menu, the Tax-Free Service of the desired provider can be activated.

<STOP> <6> <2> <5>

Deactivate TFS

In this sub-menu, the Tax-Free Service of the provider used can be deactivated.

10 Maintenance and handling

10.1 IDENTIFYING AND SOLVING ERRORS

No display

If the terminal is not placed on the loading station or programmed accordingly, it automatically switches to stand-by mode after 60 seconds. By pressing the <Corr/On> button the operation mode will be reactivated.

The rechargeable battery is not sufficiently charged

If the rechargeable battery is not sufficiently charged and transactions can no longer be conducted correctly, no further transactions can be made.

Display:



To recharge the battery, connect the terminal to the power supply, or place it on the loading station, if present.

Host timeout

The corresponding computer centre does not reply. Possible reason: network overload.

Reading error, card cannot be read

Clean the reading unit. Card information can also be entered manually.

Audible warning signal sounds during the payment procedure

When general errors occur during the payment procedure, the terminal will repeatedly sound an audible warning signal and the request "terminal back to cashier please" will appear on the display. This message can be stopped by pressing the left function key beneath the display.

10.2 IMPROVE THE BATTERY LIFE

To save even more energy when operating your terminal, Worldline has developed a setting whereby the terminal automatically switches to standby mode when set to the appropriate programme.

In order to improve the battery life of the terminal, first activate Powermanagement.

Select the following entries on the menu in your terminal using the keypad:

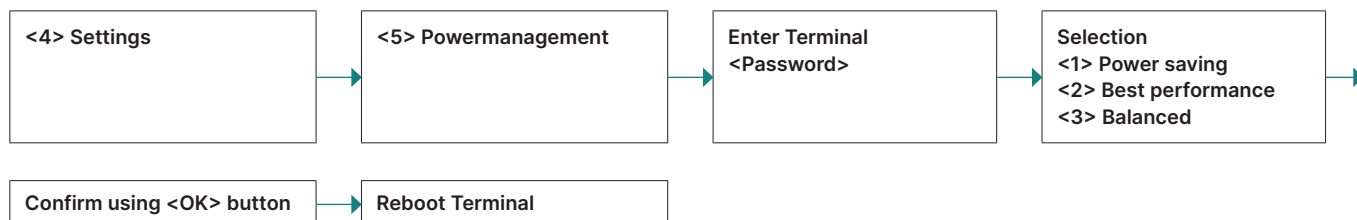

Your selected option will only come into effect once you have rebooted the terminal.

The following settings for Powermanagement are available:

Best performance/Balance

- Full power
- Standby mode¹
- Communication module remains active

Power saving²

- Full power
- Extended sleep mode¹
- Terminal is fully operational again after approx. 60 seconds

¹ The standby time can be adjusted via Terminal Support (available by phone in Switzerland on 0800 111 600 or within the EU region on +41 58 205 47 75).

² For unlimited operation of your terminal in a non-air conditioned environment, the "Power saving" setting is recommended.

10.3 CHANGING THE PAPER ROLL

- 1 Tilt the cover backwards using the push buttons.
- 2 Replace the old roll with a new one. Close the cover. Make sure the roll is inserted in the right direction!

1



2

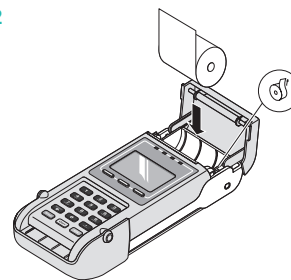

Troubleshooting

If printing is impossible, check whether the paper roll has been inserted backwards.

Do not pull the paper out if the printer cover is closed.

Ordering paper rolls

- worldline.com/merchant-services/shop (for Switzerland)
- Order form
- Terminal hotline

Your local point of contact can be found at: worldline.com/merchant-services/contacts

